

N6700 Modular Power System Family

N6705C, N6715C DC Power Analyzer Mainframes

N6731B – N6786A DC Power Modules

N6791A - N6792A Electronic Load Modules

BV9200B, BV9201B Control and Analysis Software

BV9210B, BV9211B Advanced Battery Test and Emulation Software



Table of Contents

R&D Engineers are Under Time Pressure	3
New Instrument Category for R&D Engineers to Increase Productivity.....	4
Modular System Based on DC Power Supply or Electronic Load Outputs.....	5
Voltmeter/Ammeter: Meter View	6
Oscilloscope: Scope View	7
Data Logger View	8
Arbitrary Waveform Generator	10
Additional Features	12
Choosing the Right DC Power or Electronic Load System to Meet Your ATE Needs.....	19
DC Electronic Load Module Feature Map	21
DC Power Module Feature Map.....	22
DC Power Module Key Performance Specifications.....	24
DC Electronic Load Module Key Performance Specifications	25
DC Power Analyzer Mainframe Key Characteristics.....	26
Ordering Information	27
Need a power solution for ATE?	34

R&D Engineers are Under Time Pressure

- Ideal for R&D testing and design validation
- Sources and measures DC voltage and current into your device under test
- Combines one to four DC power supplies or Electronic loads, DMM, oscilloscope, arbitrary waveform generator, and data logger in one integrated instrument
- Saves time – no programming required
- Eliminates the need to gather and configure multiple instruments
- Flexible, modular system: Lets you mix and match DC source power levels and measurement performance levels to optimize your investment
- Connect via GPIB, LAN, or USB
- Fully compliant to LXI Class C specification
- Electronic load module for power supply testing

Due to increasing time-to-market pressures, research and development engineers often find themselves on tight schedules to work through device under test (DUT) testing. Along with being driven faster, the R&D engineers can face a high regret factor should their haste result in damaging scarce, complex or expensive DUTs during product development. This is a particular concern when tests involve applying DC power or electronic load to a DUT. Furthermore, test complexity increases when testing devices that require multiple input voltages, such as printed circuit boards.

Today, when performing DC power-related tests, R&D engineers must gather and configure multiple instruments to complete DC sourcing or loading and measurement tasks. When executing these complex tasks, which can involve simultaneously connecting to and physically interacting with multiple test instruments, the risk of error increases. In response, R&D engineers may choose to automate tests that are too complex to do manually. Unfortunately, while automating tasks reduces human error, writing and debugging programs adds more work to already overloaded R&D engineers.

The Keysight Technologies, Inc. N6705 DC Power Analyzer represents an entirely new instrument category for R&D engineers. It provides unrivaled productivity gains when sourcing or loading and measuring DC voltage and current into a DUT. Using the Keysight N6705 DC Power Analyzer, R&D engineers can gain insights into the DUT's power consumption in minutes without writing a single line of code. It provides an easy-to-use interface, with all sourcing or loading and measuring functions available from the front panel.

New Instrument Category for R&D Engineers to Increase Productivity

The Keysight N6705 DC power analyzer saves time

- Provides unrivaled productivity gains for sourcing or loading and measuring DC voltage and current into your DUT by integrating up to four advanced power supplies with DMM, scope, arbitrary waveform, and data logger features.
- Eliminates the need to gather multiple pieces of equipment, create complex test setups including transducers (such as current probes and shunts) to measure current into your DUT.
- Eliminates the need to develop and debug programs to control a collection of instruments and take useful measurements because all the functions and measurements are available at the front panel.

The Keysight N6705 DC power analyzer makes these tasks easy, right from the front panel

- Setup and view critical turn-on/turn-off sequences.
- Measure and display voltage, current versus time to visualize power into the DUT.
- Control DC bias supply or electronic load ramp-up/down rates.
- Generate DC bias supply or loading transients and disturbances (arbs).
- Log data for seconds, minutes, hours, or even days to see current/power consumption or capture anomalies.
- Save data and screen shots to internal storage or external USB memory devices.
- Save and name your setup and tests for easy re-use.
- Share setups with colleagues.

The Keysight BV9200B control and analysis software saves even more time

The BV9200B control and analysis software is a companion PC application that lets you control any of the N6700 family's DC power modules or electronic load modules when installed in up to four N6705 mainframes – from a single PC control screen. With this software, you get improved data visualization and data management.

- Compliments the N6705 DC power analyzer's front panel controls.
- Control and analyze data from up to four N6705 DC power analyzer mainframes and any installed modules at once – up to 16 power modules or electronic load modules simultaneously.
- Easily create complex waveforms to simulate or load down a DUT by inputting a formula, choosing from built-in, or importing waveform data.
- Integrate software functions into users programming environment via API (automation programming interface)
- Enhanced control and analysis of data with familiar PC controls and large display.
- Data log measurements directly to a PC.
- Perform statistical analysis of power consumptions.

For more information, visit www.keysight.com/find/BV9200

Modular System Based on DC Power Supply or Electronic Load Outputs

The Keysight N6705 DC power analyzer is a modular system that can be tailored to meet specific test needs. At the heart of the DC power analyzer is the DC power or load module. The Keysight N6705 DC power analyzer is a mainframe that has four slots to accept one to four DC power or load modules. Each DC power or load module takes one slot, except for the N6750 high-performance autoranging and N6760 precision power modules that are ≥ 300 W, and N6792A which occupy two slots. This modular design gives you the flexibility to mix and match over thirty different modules to create a solution optimized to meet specific test requirements.

R&D engineers can invest in high-performance outputs where speed and accuracy are needed, or purchase basic performance outputs for simple DC power requirements. In the future, as your test needs change, you can purchase different modules and swap them into the DC power analyzer, thus creating a solution that protects your investment and grows with you.

Each DC power module and electronic load module output is fully isolated and floating from ground and from each other.



Figure 1. The Keysight N6705 DC power analyzer with BV9200B software.

Feature	Benefit
Integrates capabilities of power supply DMM, scope, arb, and data logger	Saves time by eliminating the need to find and interconnect multiple instruments. Provides synergistic functions not available from separately connected instruments.
Large color graphics display	Fast, simple, quick, set-up and monitoring. Ability to visualize results of multiple channels.
Connections and controls color-coded to the display	Fast set-up and control. Confidence that you are configured and testing correctly.
Intuitive, dedicated physical controls for common functions	Fast set-up and control using a familiar interface, with each instrument function behaving like its standalone counterpart.
Access all capabilities without programming	Reduce 90% of the effort associated with set-up by eliminating the need for a PC, drivers, and software.

The N6730, N6740, and N6770 Series of basic DC power modules	50 W, 100 W, and 300 W; up to 150 V, up to 20 A
The N6750 Series of high-performance, autoranging DC power modules	50 W, 100 W, 300 W and 500 W; up to 60 V, up to 50 A
The N6760 Series of precision DC power modules	50 W, 100 W, 300 W and 500 W; up to 60 V, up to 50 A
The N6780 Series of application-specific power modules	Up to 80 W; up to 20 V, up to ± 8 A
The N6790 Series of DC electronic load modules	Up to 200 W; up to 60 V, up to 40 A

Voltmeter/Ammeter: Meter View

Each DC power or load module in the Keysight N6705 DC power analyzer has a fully integrated voltmeter and ammeter to measure the actual voltage and current being sourced out of the DC output into the DUT. Because this voltmeter/ammeter function is built in, it is easy to make measurements without additional wires or the added complexity of current sense resistors or current shunts. The accuracy of the voltage and current measurements are based on the type of module that is installed (load, basic, high-performance, precision, or SMU). You can find the accuracy specification in the tables starting on page 24 under “Voltage Measurement Accuracy” and “Current Measurement Accuracy.” *

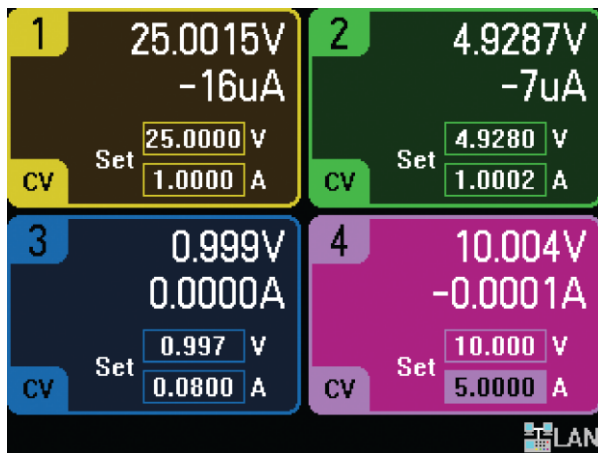

Figure 2. In Meter View, all 4 outputs can be viewed simultaneously. The both measured values for voltage and current and setting for voltage and current are displayed for each output.

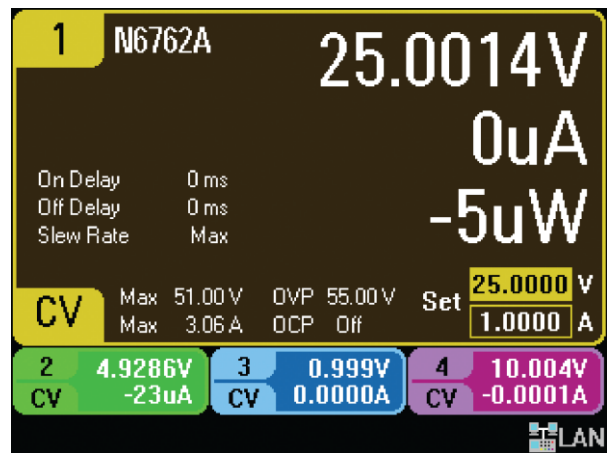

Figure 3. In Meter View, you can also view an enlarged view of one channel, displaying many settings and measured values, for that channel. A summary is shown for the other three channels.

* Complete specifications are available at <http://literature.cdn.keysight.com/litweb/pdf/N6700-90001.pdf>

Oscilloscope: Scope View

Each DC power or load module in the Keysight N6705 DC power analyzer has a fully integrated digitizer to capture the actual voltage-versus-time and current-versus-time being sourced from the DC output into the DUT. The digitized data appears on the large color display just like an oscilloscope. Because this oscilloscope function is built in, it is possible to make current measurements without current sense resistors, current shunts, or current probes. This greatly reduces measurement setup complexity and provides for accurate and fully specified, calibrated measurements. The accuracy of the measurements in oscilloscope mode is based on the type of power module installed (load, basic, high-performance autoranging, precision, and SMU). You can find this information in the Keysight N6700 Modular Power System Family Specifications Guide under “Oscilloscope Measurement Accuracy.” *

The N6790A, N6760 and N6780 SMU series of power modules offer simultaneous digitizing of output voltage and output current, such that you can view a voltage trace and a current trace at the same time on the oscilloscope display. For all other module types, you can select to view either a voltage trace or a current trace on the oscilloscope display.

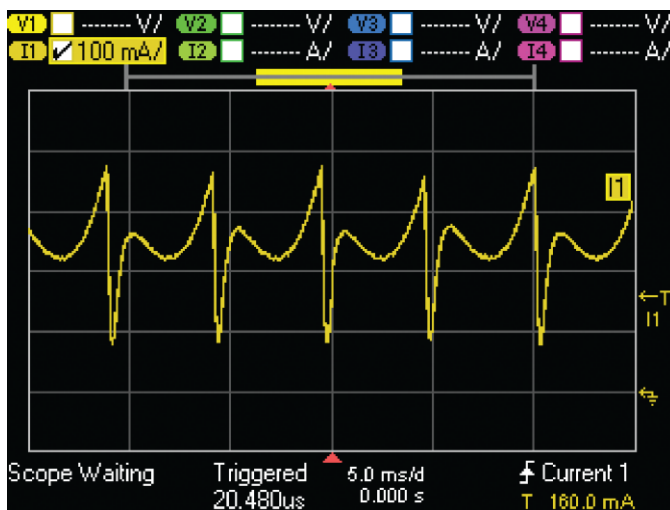

Figure 4. In scope view, voltage and current traces are displayed. In this picture, the DC current flowing into the DUT is clearly visible as a time-varying waveform

The table below shows the relationship between the number of scope traces, the sample rate, and the buffer size available for each trace. As shown, the digitizer can run at up to 200 kHz with up to 256 k samples per trace (512 k samples with SCPI commands). With an effective measurement bandwidth of up to 30 kHz, this oscilloscope function is perfectly matched to capture time varying events on the DC output, such as peak current demand, dropouts, rise times and other DC transients and disturbances.

The measurement buffer size can be set to between 1 k and 256 k points. Whatever buffer size is selected, its available points must be divided by the total number of traces being measured.

* Complete specifications are available at <http://literature.cdn.keysight.com/litweb/pdf/N6700-90001.pdf>

Note that the measurement window is determined by multiplying the selected buffer size by the sample rate. For a measurement window of 60 seconds for example, with a buffer size set to 256 k points, the fastest sample rate available to you will be 234 microseconds. If the buffer size is set to 64 k points, the fastest available sample rate will be 937 microseconds.

Module type	Number of traces (1 trace = V or I)	Fastest sample rate	Maximum buffer size available per trace
One N6780 SMU or N6790A	1 trace	5.12 μ s (~ 200 kHz)	256 k points
Any power module	1 or 2 traces	10.24 μ s (~ 100 kHz)	128 k points
Any power module	3 or 4 traces	20.48 μ s (~ 50 kHz)	64 k points

The oscilloscope can be triggered on either voltage or current levels. Because the Keysight N6705 DC power analyzer is an integrated instrument, the oscilloscope can also be easily configured to trigger on the start of an arbitrary waveform or to trigger when the DC power output is enabled. For example, to make an inrush current measurement on your DUT, you can set the oscilloscope to trigger on the DC output's on/off key, set the trigger mode to single shot, and then turn on the DC output. This will immediately capture the current flowing out of the DC module into the DUT and give a picture of the inrush current of the DUT. This integrated functionality is not available when using a collection of separate test instruments on the test bench and is an example of how the DC power analyzer reduces setup time and complexity.

Data Logger View

The Keysight N6705 DC power analyzer can also function as a data logger. Using the measurement capability built into each DC power or load module, the N6705 can continuously log data to the large color display and to a file. Data can be simultaneously logged on all four DC outputs. The accuracy of the voltage and current measurements depends on the type of module that is installed (load, basic, high-performance, precision, and SMU).

As illustrated in the table below, there are two modes of operation:

- In standard mode, measurements are spaced by the sample period, which is programmable from 75 milliseconds to 60 seconds. For each DC output, voltage measurements, current measurements, or both can be logged. Each reading is an integrated voltage or current measurement. Standard mode data logging is available on all DC power or load module types.
- In continuous sampling mode, the built-in digitizer of the DC power module runs continuously at 50,000 readings per second. You can specify a sample period, which is the period of time during which these continuous readings will be accumulated. For each sample period, one average reading (and optionally, a minimum and maximum value) is saved. In this mode, the digitizer runs continuously as the readings are averaged and stored; therefore, the digitizer is always making measurements and no data is missed. The sample period is programmable from 20 microseconds to 60 seconds. In this mode, the N6790A, N6760 and N6780 SMU series of modules offer simultaneous logging of output voltage and output current. For all other module types, you can log either voltage or current when in continuous sampling mode.

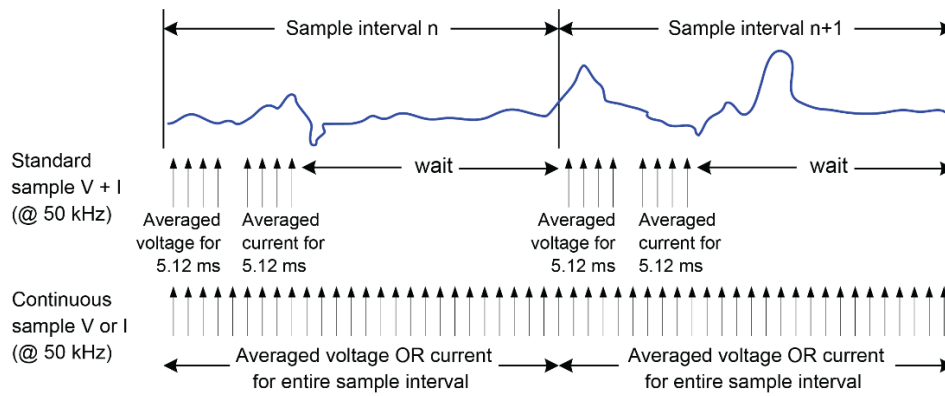

	Standard data logging	Continuous data logging
Sample interval range	75 milliseconds to 60 seconds	20* microseconds to 60 seconds * Add 20 μ s for each additional parameter (Voltage, Current, Min, or Max)
Sample rate	50 kHz	200 kHz for N6780 SMU and N6790A 50 kHz for all others
Data logging mode used by N6705	Automatically selected when any N6730, N6740, N6750, or N6770 are set to sample BOTH voltage and current.	Automatically selected when any N6730, N6740, N6750 or N6770 is set to measure either voltage or current. Note that N6790A, N6760 and N6780 SMU modules can be set to sample BOTH.

The maximum data log file size is ~2 gigabytes, which is approximately one billion readings. The data file can be stored on the N6705's internal non-volatile RAM or saved externally on a USB memory device.

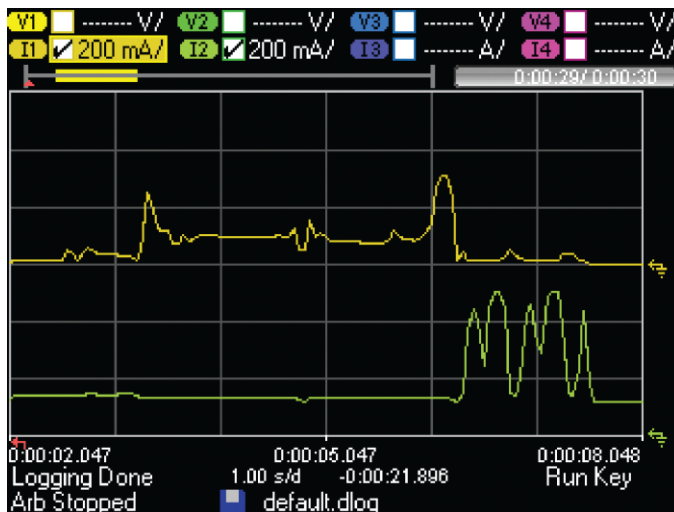

Figure 5. In Data Logger View, you can log data on multiple traces. Here, the current flowing out of output 1 and output 2 are captured over 30 seconds.

Arbitrary waveform	Number of points per waveform
Exponential	100 points
Trapezoid	100 points
User-defined waveform (where the output is a voltage or current source)	Up to 512 points with point-by-point adjustable dwell
Constant-dwell waveform	Up to 64,000 points with programmable dwell (same for all points)

For each waveform, you can set it to repeat continuously or you can specify the number of times the waveform is repeated. For example, to generate a pulse train of 10 identical pulses, you can program the parameters for one pulse and then specify that you want it to repeat 10 times.

For user-defined voltage and current waveforms, you can download up to 512 setpoints of voltage or current. With loads, waveforms can be generated in voltage, current, resistance, and power. For each setpoint, a dwell time is specified and output will stay (i.e., dwell) at that setpoint for the programmed dwell time value. For each of the 512 setpoints in the user-defined waveform, you can have a different dwell time from 0 to 262 seconds with 1 microsecond resolution. The module will step through the user-defined table of values, staying at each setpoint for the programmed dwell time, and then it will move on to the next point. User-defined waveforms can be imported from a CSV file or directly entered from the front panel of the DC power analyzer.

Constant-dwell voltage or current waveforms can also be generated, with up to 64000 programmable points. With loads, voltage, current, resistance, and power is available.

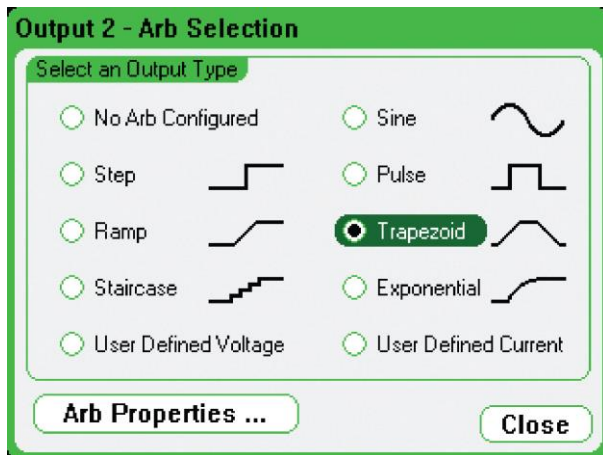

Figure 7. The Arb Selection menu is used to select which pre-programmed waveform will be applied to the output of the DC power module. Each of the four outputs can have a different waveform applied.

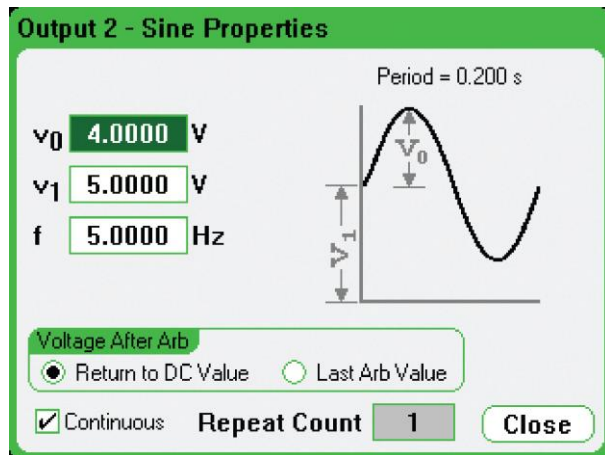

Figure 8. Once you have selected a waveform, you simply fill in the blanks to describe the waveform.

Additional Features

Output sequencing

Each DC power or load module can be individually set to turn on or turn off with a delay. By adjusting the delay times and then commanding the Keysight N6705 to turn on, you can set the Keysight N6705 modules to sequence on in a particular order. The same sequencing capability is available to shut down the modules in particular order. Delay times can be set from no delay to one thousand seconds of delay in one-millisecond increments.

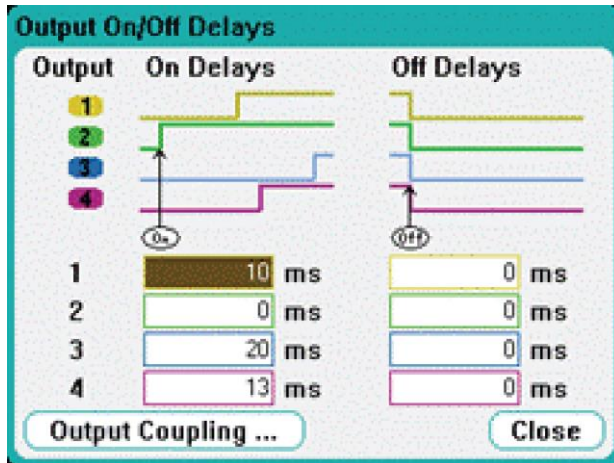

Figure 9. The Output On/Off Delays screen allows you to enter the delay times for each output. A graphical representation of the settings is shown to visually confirm your choices.

For applications that require more than four DC power or load modules to be sequenced, this output sequencing can be extended across multiple Keysight N6705 mainframes. By wiring the I/O ports on the rear panel of the mainframes together, a pair of synchronization signals is sent between mainframes, allowing the output sequences of each mainframe to be synchronized.

This capability is also supported to link Keysight N6705 output sequences with outputs installed in N6700C, N6701C and N6702C Low-Profile Modular Power System mainframes.

Programmable voltage slew

For some applications, like inrush limiting or powering rate-sensitive devices, it is necessary to slow down and control the speed of the DC output to maintain a specific voltage slew rate. The Keysight N6705 provides programmable voltage slew rate, so that you can easily control the speed at which the output slews from one voltage to another. You can set the speed of a voltage change anywhere from its maximum up/down programming speed to its slowest change of up to 10 seconds.

Series and parallel operation

To increase available voltage and power per output, identically rated outputs can be operated directly in series. The maximum series operation is 240 V. To increase the available current and power per output, identically rated outputs can be operated directly in parallel. The maximum rated parallel operation is 100 A per Keysight N6705.

Convenient front panel connections

The N6705 uses 3-way binding posts on the front panel for connection to the DUT. The binding posts accept standard banana plugs, bare wire, and spade-lug connectors. The binding posts are rated for 20 A per post. To avoid setup and connection errors, the binding posts are color-coded to the control keys and the display. For modules with outputs rated at greater than 20 A, such as the N6753A or N6792A, high current wires must be brought out through the N6705's rear panel.

The N6705C mainframe provides rear panel access ports to route these wires.

4-wire sensing for improved measurement accuracy

To improve the voltage measurement accuracy and regulation of the DC outputs, the Keysight N6705 DC power analyzer offers 4-wire sensing capability, also called remote sensing, on each of the four outputs of the DC power analyzer. 4-wire remote sensing is useful when the DUT draws high current and you want to account for voltage drop in the power leads to achieve tight regulation and high voltage measurement accuracy.

To use 4-wire sensing in addition to your power leads, you must connect two low current sensing leads between the DUT input terminals and 4-wire sense terminal binding posts located on the front of the N6705 mainframe. This permits the output module to monitor and regulate its output voltage directly at the DUT input terminals instead of the N6705 front panel output binding posts. It then automatically adjusts its output voltage to compensate for voltage drops across the resistance in the power leads.

For convenience, switching between 2-wire mode (local sensing) and 4-wire mode (remote sensing) is done via an internal relay inside the N6705 DC power analyzer, eliminating the need for shorting bars or jumpers commonly found on other bench power sources.

DC power modules offer low noise outputs

Careful attention has been paid to this design to ensure low normal mode noise (ripple and peak-peak) as well as low common mode noise. While all DC power modules are switching power supplies, the N6750 high-performance autoranging DC power modules, the N6760 precision DC power modules, and the N6780 Source Measure Units are switching power supply designs that outperform most linear power supplies on the market.

DC power modules provide fast voltage changes

When it comes to speed, the N6750 high-performance autoranging DC power modules, the N6760 precision DC power modules, and the N6780 Source Measure Units achieve performance unlike a typical DC power supply. Thanks to an active down-programming circuit to rapidly pull down the output when lowering the output voltage, these power modules can rapidly program both up and down in voltage. Changing voltage from 0 V to 50 V, or 50 V to 0 V for example, can be accomplished in less than 1.5 milliseconds.

Note that for smaller voltage changes, from 0 V to 5 V or 5 V to 0 V for example, the programming speed is less than 200 microseconds. These output speeds allow the N6750/60/80 to give maximum system through-put when your test calls for frequent changes in power supply voltage settings.

Autoranging for flexibility

The N6750 high-performance auto-ranging DC power modules and the N6760 precision DC power modules give you even more flexibility by providing autoranging outputs. This autoranging capability provides maximum output power at any output voltage up to 60 V. This allows one power supply to do the job of several power supplies, because its operating range covers low voltage, high current as well as high voltage, low current operating points. For example, the N6755A high-performance, autoranging DC module, rated at 20 V, 50 A, and 500 W can provide full power at:

10 V @ 50 A (= 500 W),
20 V @ 25 A (= 500 W),
15 V @ 33 A (= 500 W),
or anywhere in between.

Therefore, this 500 W autoranging power supply, due to its extended voltage and current range, can produce voltage and current combinations in the range of a 1000 W non-autoranging power supply.

Real time clock

The Keysight N6705 DC power analyzer has a built-in battery backed real time clock. This allows for proper time-stamping of logged data. It is also used to tag files with correct creation dates.

Front panel USB

The Keysight N6705 DC power analyzer provides a convenient front panel USB port designed exclusively for data storage devices, such as USB memory devices or USB hard drives. On devices connected to this USB port, you can save test setups, test results, and screen images. It is also an easy way to move test setup files between two N6705 DC power analyzers or test results between the DC power analyzer and a PC. You can also log data directly to the USB device plugged into the front panel. This extends the total storage capability of the N6705.



Figure 11. The N6705's front panel USB port.

Internal memory

The Keysight N6705 DC power analyzer has 4 gigabytes of non-volatile storage. This storage is shared between the four DC outputs. It can be used for saving test setups, test results, and screen images. External USB storage is supported for increased storage capacity to log data longer.

Emergency stop

Should a hazardous situation occur during testing, you can press the large red emergency stop button on the front panel of the Keysight N6705. Pressing this easy-to-find button immediately removes power from the DC outputs. However, any data collection (such as a scope trace or data log) that is running at the time will continue to run. By doing so, the data you were collecting is saved and you will get a record of what was happening at the time of the event that caused you to press the emergency stop button. The measurements could aid in failure analysis, repair, or debugging of the DUT.



Figure 12. The emergency stop button shuts down all outputs immediately.

DUT protection features

Each Keysight N6705 DC power module is protected against over-voltage, over-current, and over-temperature. A fault condition in one module can be detected within 10 microseconds by other modules so that they can be quickly shut down to avoid hazardous conditions on your DUT.

Output disconnect and polarity reversal relays

Power modules in the Keysight N6705 can be individually ordered with optional Output Disconnect Relays (option 761) or Output Disconnect/Polarity Reversal Relays (option 760). See table on page 27 for option 760 and 761 availability. All relays are built into the module, so no additional wiring is needed to incorporate the relay function.

Although the plus and minus rail of the output power mesh are physically disconnected from the output terminals with options 760 and 761, a small AC network is still connected across the plus and minus output terminals. This AC network is required for EMI compliance.

With option 761, Output Disconnect Relays, an emergency condition or turning the DC output off causes mechanical relays disconnect both the plus and minus side of the power supply, including the sense leads.

With option 760, Output Disconnect/Polarity Reversal Relays, mechanical relays switch the leads on both the plus and the minus side of the power supply, including the sense leads, resulting in a voltage polarity reversal at the DUT. In addition to polarity reversal, option 760 provides the same output disconnect function as option 761.

Note: Output current is limited on some modules when option 760 Output Disconnect/Polarity Reversal Relays is installed. See the “Available options” tables on page 27 for more information about maximum current limitations with option 760.

Triggering

The Keysight N6705 DC power analyzer has hardware trigger in/trigger out signals which permit the Keysight N6705 to be synchronized with other test equipment. For example, when you turn on the outputs of the Keysight N6705, it can generate a trigger signal to start a measurement on an RF power meter.

Connectivity

The Keysight N6705 DC power analyzer comes standard with GPIB, USB 2.0, and 10/100 base-T ethernet LAN interfaces. The Keysight N6705 is fully compliant with the LXI class C specification.

Security

All non-volatile RAM data and settings can be cleared from the front panel. For customers who have security concerns about USB access to internally stored test data and setups, the Keysight N6705 also offers option AKY, which removes the USB ports from the front and rear of the Keysight N6705. When used in systems running GPIB, the LAN and/or USB interfaces can be disabled for extra security.

Control from any browser

The Keysight N6705 can be controlled via a standard web browser. The Keysight N6705 contains a web server that provides a webpage containing a graphical front panel representation of the Keysight N6705 front panel. The Web GUI operation is identical to operating the real front panel on the Keysight N6705 DC power analyzer.

Drivers

For customers who wish to operate the DC power analyzer under computer control, the Keysight N6705 comes with both *VXIplug&play* drivers and IVI-COM drivers. LabView drivers are available at NI.COM.

Programming language

The Keysight N6705 supports SCPI (Standard Commands for Programmable Instruments). Note that the Keysight N6705's command set is compatible with the N6700 modular power system for ATE, so programs written for the Keysight N6700 will work on the Keysight N6705.

Firmware updates

The Keysight N6705 firmware is stored in FLASH ROM and can be easily updated when new features become available. Firmware can be downloaded into the Keysight N6705 over GPIB, LAN, or USB using the supplied firmware update utility program. Firmware updates can be found at www.keysight.com/find/N6705firmware.

BV9200 Pathwave BenchVue Advanced Power Control and Analysis Software

For details visit www.keysight.com/find/BV9200

BV9210 Pathwave BenchVue Advanced Battery Test and Emulation Software

Provides a test environment for you to easily run battery tests, generate battery models and perform battery emulation. Options for multiple instruments (BV9210B) and a single instrument (BV9211B) are available. For details visit www.keysight.com/find/BV9210B and www.keysight.com/find/BV9211B.

Makes a great tool for ATE systems that require an advanced user interface for test and debug

While the Keysight N6705 DC power analyzer is designed primarily as an R&D bench tool, customers building ATE systems may find the Keysight N6705 has great utility in an ATE system. It is fully programmable, LXI class C certified, and takes the same commands as the Keysight N6700. But thanks to its large display and easy to use controls, test engineers may find the Keysight N6705 makes a great tool for visualizing test results as the tests execute, for DUT troubleshooting, for DUT debugging, and for ATE test development. The Keysight N6705 mounts in a standard 19" rack using standard rack mount hardware for 4 U instruments.

Achieve correlation and share data between R&D and manufacturing

The Keysight N6705 DC power analyzer is a modular system that uses the same DC power modules as the N6700 low-profile modular power system for ATE. Customers who use the N6705 in R&D and the N6700 in manufacturing can easily achieve test correlation between R&D testing, design characterization/validation testing, and manufacturing testing because the DC power or load modules are common to both the bench and ATE versions of the product. Test programs can be easily shared between R&D and manufacturing since the Keysight N6705 and the Keysight N6700 share a common command set.

Power management feature allows you to allocate N6705 mainframe power

Often, a DUT requires some high power DC sources and several very low power DC sources. In this case, you may choose to configure a system where the sum of the power modules installed in the Keysight N6705 exceeds the total power available from the Keysight N6705 mainframe. The power management features of the Keysight N6705 allow you to allocate mainframe power to the outputs where it's needed, achieving maximum asset utilization and flexibility. This feature provides safety from unexpected and dangerous shutdowns that can occur with power systems without power management when operated in a similar way. For example, if your DUT requires 250 W on two of its inputs, but only 10 W each on two auxiliary inputs, you can configure a system consisting of two 300 W DC modules and two 50 W DC modules. Although the sum of the module power is greater than 600 W, you can still use the Keysight N6705. Thanks to the power management feature, you can allocate the 250 W each to the two 300 W modules while you allocate only 25 W to each of the 50 W modules.

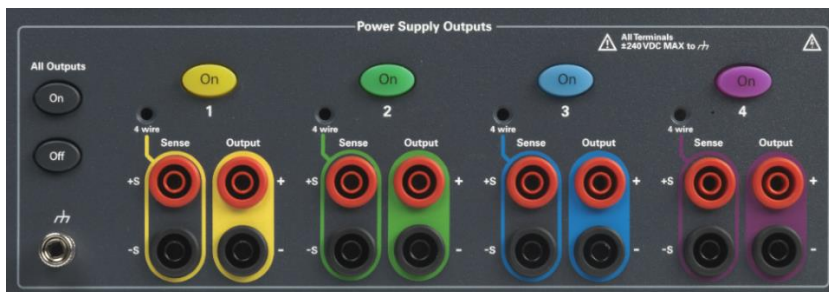

Figure 13. Option RBP recessed binding post

Universal AC input

The Keysight N6705 has a universal input that operates from 100-240 VAC, 50/60/400 Hz. There are no switches to set or fuses to change when switching from one voltage standard to another. The AC input employs power factor correction.

Choosing the Right DC Power or Electronic Load System to Meet Your ATE Needs

N6790 Electronic Load Series

The new Keysight N6790 Series Modular Electronic Loads offer a 100W module and a 200W module each in a 1U footprint. Four different user operation modes are available: constant voltage, constant current, constant resistance, and constant power. With a high, accurate measurement system and digitizing capabilities, users can easily gain insight into their power supply test. Also, the new series offers a powerful, built-in arbitrary waveform generator which allows users to emulate complex dynamic load waveforms. This is a must have for any serious power system designer and test engineer.



Fig 14a. The Electronic Load Series

N6750 High-Performance Series

For applications where the power supply plays a critical role – Now with available power up to 500 W

The Keysight N6750 Series of high-performance, autoranging DC power modules provides low noise, high accuracy and programming speeds that are up to 10 to 50 times faster than other programmable power supplies. In addition, Keysight has, for the first time, included high-speed test extensions in general-purpose power supplies. The high-speed test extensions offer an oscilloscope-like digitizer that simplifies system configuration and increases measurement accuracy when viewing high-speed transient or pulse events within the DUT. In addition, autoranging output capabilities enable one power supply to do the job of several traditional power supplies.



Figure 14b. The N6753A – N6756A High performance and the N6763A – N6766A Precision DC power modules each occupy two module slots within the mainframe. All other modules occupy 1 module slot.

N6760 Precision Series

For applications where precision is required – Now with available power up to 500 W

The Keysight N6760 Series of precision DC power modules provides precise control and measurements in the milliampere and microampere region with the ability to simultaneously digitize voltage and current, and capture those measurements in an oscilloscope-like data buffer.

N6730/40/70 Basic Series

For basic DC applications – Now with voltages up to 150 V

The Keysight N6730, N6740 and N6770 Series of DC power modules provide programmable voltage and current, measurement and protection features at a very economical price, making these modules suitable to power the DUT or to provide power for ATE system resources, such as fixture control.



Fig 14c. The basic series

N6780 SMU Series

For applications where multi-quadrant operation and high-precision are required

For details on these products and how they can be used for applications including battery drain analysis and function test, visit www.keysight.com/find/N6780 and download the *N6780 Series Source/Measure Units (SMUs) for the N6700 Modular Power System Data Sheet*, literature number 5990-5829EN.

N6783 application-specific series

For details on these products and how they can be used for specific applications visit www.keysight.com/find/N6783A-BAT, www.keysight.com/find/N6783A-MFG and download the *N6783A-BAT Data Sheet*, 5990-8662EN and the *N6783A-MFG Data Sheet*, 5990-8643EN.

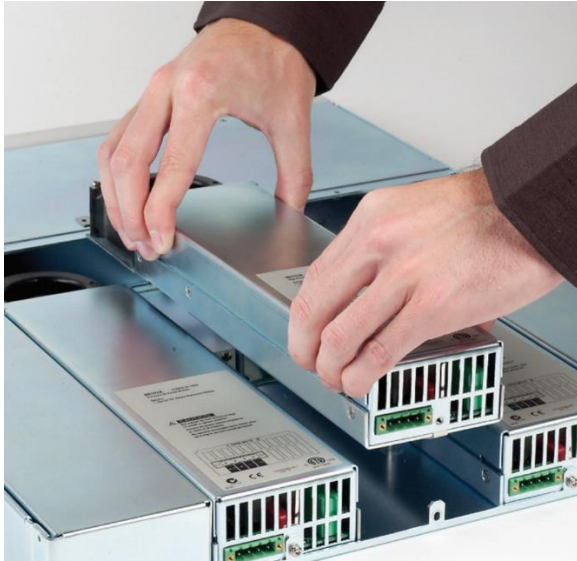

Figure 14d. User re-configurable modular system

DC Electronic Load Module Feature Map

For detailed product specifications and characteristics, refer to the *Keysight N6700 Modular Power System Family Specifications Guide* at <http://literature.cdn.keysight.com/N6700-90001.pdf>.

Feature (* = available)	Load Module	
	N6791A	N6792A
Input rating ¹	100 W	200 W
Input terminal short capability	•	•
Arbitrary waveform generation	•	•
Under voltage inhibit	•	•
Voltage, current, power, and resistance priority	•	•
Number of resistance input ranges	3	3
Number of current input and measurement ranges	2	2
Number of voltage input and measurement ranges	1	1
Number of power measurement ranges	3	3
Simultaneous voltage and current measurements	•	•
SCPI command output list capability ²	•	•

Feature (* = available)	Load Module	
	N6791A	N6792A
SCPI command array readback ²	•	•
SCPI command programmable sample rate ²	•	•
SCPI command external data logging ²	•	•
Double-wide (Occupies two channel locations)		•

1. The load module's input is referred to by the term "Output" throughout this document.
2. Only available when using the remote interfaces; not from the front panel.

DC Power Module Feature Map

Feature (* = available)	DC power N673xB, N674xB, N677xA	High-performance N675xA	Precision N676xA
50 W output rating	N6731B – N6736B	N6751A	N6761A
100 W output rating	N6741B – N6746B	N6752A	N6762A
300 W output rating	N6773A – N6777A	N6753A, N6754A	N6763A, N6764A
500 W output rating		N6755A, N6756A	N6765A, N6766A
Output disconnect relays	Option 761	Option 761	Option 761
Output disconnect/polarity reversal relays	Option 760	Option 760	Option 760
Autoranging output capability		•	•
Voltage or current turn-on priority			N6761A, N6762A
Precision voltage and current measurements			•
Low voltage and current output ranges			N6761A, N6762A
Low voltage and current measurement ranges			•
200 μ A measurement range (N6761A/N6762A only)			Option 2UA
Simultaneous voltage and current scope traces			•
Output list capability (High speed test extensions)	•	•	•
Array readback capability (High speed test extensions)	•	•	•
Programmable sample rate (High speed test extensions)	•	•	•
Double-wide (Occupies two channel locations)		N6753A - N6756A	N6763A - N6766A

Feature (* = available)	Source/measure units (SMU)					Application-specific	
	N6781A	N6785A	N6782A	N6786A	N6784A	N6783A-BAT	N6783A-MFG
Output rating	20 W	80 W	20 W	80 W	20 W	24 W	18 W
2-quadrant operation	•	•	•	•			
4-quadrant operation					•		
Auxiliary voltage measurement input	•	•					
Output disconnect relays	•	•	•	•	•	Option 761	Option 761
Arbitrary waveform generation	•	•	•	•	•	•	•
Negative voltage protection	•	•	•	•	•	•	•
Voltage or current priority mode	•	•	•	•	•		
CC load/CV load	•	•	•	•	•		
Battery emulator/charger	•	•	•	•	•		
Voltage/current measurement only	•	•	•	•	•		
Programmable output resistance	•	•					
600 mV output range	•		•		•		
300 mA output range	•		•				
100 mA, 10 mA output ranges					•		
1 V, 100 mV measurement ranges	•				•		
100 mA, 1 mA, 10 μ A measurement ranges	•		•		•		
8 A, 100 mA, 1 mA measurement ranges		•		•			
150 mA measurement range						•	•
Voltage or current scope traces	•	•	•	•	•	•	•
Simultaneous voltage and current scope traces	•	•	•	•	•		
Simultaneous voltage and current data logging	•	•	•	•	•		
Interleaved voltage and current data logging						•	•
Seamless measurement autoranging	•	•	•	•			
SCPI command list capability	•	•	•	•	•	•	•
SCPI command array readback	•	•	•	•	•	•	•
SCPI command programmable sample rate	•	•	•	•	•	•	•
SCPI command external data logging	•	•	•	•	•	•	•
SCPI command histogram measurements	•	•	•	•			

DC Power Module Key Performance Specifications

Note: This data sheet does not include a comprehensive list of all power module specifications and characteristics. Complete performance specifications and supplemental characteristics for all power modules can be found at <http://literature.cdn.keysight.com/litweb/pdf/N6700-90001.pdf>. See the *Keysight N6700 Modular Power System Family Specifications Guide*, part number N6700-90001.

	DC output ratings (volts/amps/watts)	Ripple & noise (p-p/rms)	Voltage programming accuracy	Current programming accuracy	Voltage measurement accuracy	Current measurement accuracy
N6731B	5 V/10 A/50 W	10 mV/2 mV	0.1% + 19 mV	0.15% + 20 mA	0.1% + 20 mV	0.15% + 20 mA
N6732B	8 V/6.25 A/50 W	12 mV/2 mV	0.1% + 19 mV	0.15% + 20 mA	0.1% + 20 mV	0.15% + 10 mA
N6733B	20 V/2.5 A/50 W	14 mV/3 mV	0.1% + 20 mV	0.15% + 20 mA	0.1% + 20 mV	0.15% + 5 mA
N6734B	35 V/1.5 A/52.5 W	15 mV/5 mV	0.1% + 35 mV	0.15% + 20 mA	0.1% + 35 mV	0.15% + 4 mA
N6735B	60 V/0.8 A/50 W	25 mV/9 mV	0.1% + 60 mV	0.15% + 20 mA	0.1% + 60 mV	0.15% + 4 mA
N6736B	100 V/0.5 A/50 W	30 mV/18 mV	0.1% + 100 mV	0.15% + 10 mA	0.1% + 100 mV	0.15% + 2 mA
N6741B	5 V/20 A/100 W	20 mV/2 mV	0.1% + 19 mV	0.15% + 20 mA	0.1% + 20 mV	0.15% + 20 mA
N6742B	8 V/12.5 A/100 W	12 mV/2 mV	0.1% + 19 mV	0.15% + 20 mA	0.1% + 20 mV	0.15% + 10 mA
N6743B	20 V/5 A/100 W	14 mV/3 mV	0.1% + 20 mV	0.15% + 20 mA	0.1% + 20 mV	0.15% + 5 mA
N6744B	35 V/3 A/105 W	15 mV/5 mV	0.1% + 35 mV	0.15% + 20 mA	0.1% + 35 mV	0.15% + 4 mA
N6745B	60 V/1.6 A/100 W	25 mV/9 mV	0.1% + 60 mV	0.15% + 20 mA	0.1% + 60 mV	0.15% + 4 mA
N6746B	100 V/1 A/100 W	30 mV/18 mV	0.1% + 100 mV	0.15% + 10 mA	0.1% + 100 mV	0.15% + 2 mA
N6751A	50 V/5 A/50 W	4.5 mV/0.35 mV	0.06% + 19 mV	0.1% + 20 mA	0.05% + 20 mV	0.1% + 4 mA
N6752A	50 V/10 A/100 W	4.5 mV/0.35 mV	0.06% + 19 mV	0.1% + 20 mA	0.05% + 20 mV	0.1% + 4 mA
N6753A	20 V/50 A/300 W	5 mV/1 mV	0.06% + 10 mV	0.1% + 30 mA	0.05% + 10 mV	0.1% + 30 mA
N6754A	60 V/20 A/300 W	6 mV/1 mV	0.06% + 25 mV	0.1% + 12 mA	0.05% + 25 mV	0.1% + 8 mA
N6755A	20 V/50 A/500 W	5 mV/1 mV	0.06% + 10 mV	0.1% + 30 mA	0.05% + 10 mV	0.1% + 30 mA
N6756A	60 V/17 A/500 W	6 mV/1 mV	0.06% + 25 mV	0.1% + 12 mA	0.05% + 25 mV	0.1% + 8 mA
N6761A ¹	50 V/1.5 A/50 W	4.5 mV/0.35 mV	0.016% + 6 mV	0.04% + 0.2 mA	0.016% + 6 mV	0.04% + 0.16 mA
N6762A ¹	50 V/3 A/100 W	4.5 mV/0.35 mV	0.016% + 6 mV	0.04% + 0.2 mA	0.016% + 6 mV	0.04% + 0.16 mA
N6763A ¹	20 V/50 A/300 W	5 mV/1 mV	0.03% + 5 mV	0.1% + 15 mA	0.03% + 10 mV	0.1% + 10 mA
N6764A ¹	60 V/20 A/300 W	6 mV/1 mV	0.03% + 12 mV	0.1% + 15 mA	0.03% + 25 mV	0.1% + 5 mA
N6765A ¹	20 V/50 A/500 W	5 mV/1 mV	0.03% + 5 mV	0.1% + 15 mA	0.03% + 10 mV	0.1% + 10 mA
N6766A ¹	60 V/17 A/500 W	6 mV/1 mV	0.03% + 12 mV	0.1% + 15 mA	0.03% + 25 mV	0.1% + 5 mA
N6773A	20 V/15 A/300 W	20 mV/3 mV	0.1% + 20 mV	0.15% + 60 mA	0.1% + 20 mV	0.15% + 15 mA
N6774A	35 V/8.5 A/300 W	22 mV/5 mV	0.1% + 35 mV	0.15% + 60 mA	0.1% + 35 mV	0.15% + 12 mA
N6775A	60 V/5 A/300 W	35 mV/9 mV	0.1% + 60 mV	0.15% + 60 mA	0.1% + 60 mV	0.15% + 12 mA
N6776A	100 V/3 A/300 W	45 mV/18 mV	0.1% + 100 mV	0.15% + 30 mA	0.1% + 100 mV	0.15% + 6 mA
N6777A	150 V/2 A/300 W	68 mV/27 mV	0.1% + 150 mV	0.15% + 30 mA	0.1% + 150 mV	0.15% + 6 mA
N6781A ¹	20 V/±3 A/20 W	12 mV/1.2 mV	0.025% + 1.8 mV	0.04% + 0.3 mA	0.025% + 1.2 mV	0.03% + 0.25 mA
N6782A ¹	20 V/±3 A/20 W	12 mV/1.2 mV	0.025% + 1.8 mV	0.04% + 0.3 mA	0.025% + 1.2 mV	0.03% + 0.25 mA

	DC output ratings (volts/amps/watts)	Ripple & noise (p-p/rms)	Voltage programming accuracy	Current programming accuracy	Voltage measurement accuracy	Current measurement accuracy
N6784A ¹	± 20 V/± 3 A/20 W	12 mV/1.2 mV	0.025% + 1.8 mV	0.04% + 0.3 mA	0.025% + 1.2 mV	0.03% + 0.25 mA
N6783A-BAT ²	8 V/-2 A to 3 A/24 W	8 mV/1.5 mV	0.1% + 10 mV	0.1% + 1.8 mA	0.05% + 5 mV	0.1% + 0.6 mA
N6783A-MFG ²	6 V/-2 A; 3 A/18 W	8 mV/1.5 mV	0.1% + 10 mV	0.1% + 1.8 mA	0.05% + 5 mV	0.1% + 0.6 mA
N6785A ¹	20 V/+/-8A/80 W	15 mV/1.5 mV	0.025%+1.8 mV	0.04%+1.5 mA	0.025%+1.8 mV	0.04%+1.5 mA
N6786A ¹	20 V/+/-8A/80 W	15 mV/1.5 mV	0.025%+1.8 mV	0.04%+1.5mA	0.025%+1.8 mV	0.04%+1.5 mA

1. These power modules have multiple output and measurement ranges; values shown are for the highest range.
2. These power modules have multiple measurement ranges; values shown are for the highest range.

DC Electronic Load Module Key Performance Specifications

Note: This data sheet does not include a comprehensive list of all power module specifications and characteristics. Complete performance specifications and supplemental characteristics for all power modules can be found at <http://literature.cdn.keysight.com/litweb/pdf/N6700-90001.pdf>. See the *Keysight N6700 Modular Power System Family Specifications Guide*, part number N6700-90001.

Performance Specifications		N6791A	N6792A
Input Ratings			
Current		0 - 20 A	0 - 40 A
Voltage		0 - 60 V	0 - 60 V
Maximum Power @ 40 °C		100 W	200 W
Specified Current @ Low Voltage Operation			
1.6 V		20 A	40 A
1 V		12.5 A	25 A
0.5 V		6.25 A	12.5 A
0.1 V		1.25 A	2.5 A
Programming Accuracy			
Current high range	20 A/40 A	0.04 % + 2.6 mA	0.04 % + 5.2 mA
Current low range	2 A/4 A	0.04 % + 0.46 mA	0.04 % + 0.92 mA
Voltage	60 V	0.03 % + 7.2 mV	0.03 % + 7.2 mV
Resistance high range	8 kΩ	± (0.1 % + 0.0014) S	± (0.1 % + 0.0028) S
Resistance medium range	100 Ω	± (0.1 % + 0.014) S	± (0.1 % + 0.019) S
Resistance low range	3 Ω	± (0.1 % + 0.38) S	± (0.1 % + 0.55) S
Power high range	100 W/200 W	0.06 % + 180 mW	0.06 % + 360 mW
Power low range	10 W/20 W	0.06 % + 30 mW	0.06 % + 65 mW

Performance Specifications		N6791A	N6792A
Measurement Accuracy			
Current high range	20 A/40 A	0.04 % + 2.4 mA	0.04 % + 4.6 mA
Current low range	2 A/4 A	0.04 % + 0.40 mA	0.04 % + 0.82 mA
Voltage	60 V	0.03 % + 7.2 mV	0.03 % + 7.2 mV
Power high range	100 W/200 W	0.06 % + 160 mW	0.06 % + 320 mW
Power low range	10 W/20 W	0.06 % + 25 mW	0.06 % + 50 mW

DC Power Analyzer Mainframe Key Characteristics

Interface capabilities	
GPIB	SCPI – 1993, IEEE 488.2 compliant interface
LXI compliance	Class C
USB 2.0	Requires Keysight IO Library version M.01.01 or 14.0 and up
10/100 LAN	Requires Keysight IO Library version L.01.01 or 14.0 and up
Environmental conditions	
Operating environment	Indoor use, installation category II (for AC input), pollution degree 2
Temperature range	0 °C to 55 °C (output current is derated 1% per °C above 40 °C ambient temperature)
Relative humidity	Up to 95%
Altitude	Up to 2000 meters
AC input	
Input ratings	~ 100 VAC – 240 VAC; 50/60/400 Hz
Power consumption	1440 VA
Power factor	0.99 @ nominal input and rated power
Net weight	
N6705 with 4 modules (typical)	16 kg/35 lbs
Dimensions	
Height/width/depth	194.7 mm/425.6 mm/313 mm
	7.665 in./16.756 in./12.319 in.

Ordering Information

The DC power analyzer system is available 2 ways

1. You can order an N6705C mainframe and various modules as separate products. (See steps below.) Each item will arrive in a separate box so that you can assemble the system yourself.
2. You can order an N6715C system, which is a build-to-order DC power analyzer system that is shipped as a fully assembled multiple-output power supply or loads. See pages 30 - 33 for N6715C ordering information.

When ordering the DC power analyzer as a mainframe and modules, follow these steps.

Step 1

Select the appropriate documentation and line cord options.

Step 2

Order 1 to 4 modules (see next page). If the sum of the power of the modules exceeds the available output power rating on the mainframe, see page 18 for an explanation of Keysight's power management capability. Note that each mainframe has 4 module slots to hold modules. Each module occupies one module slot, except for the N6753A-N6756A, N6763A-N6766A, N6785A-N6786A and N6792A which occupy two module slots.

Mainframe	
N6705C	DC power analyzer mainframe Holds 1 to 4 modules. Total available output power = 600 W
Available options to the N6705C mainframe	
1CM113A	Rack mount kit
AKY	Delete front/rear USB This option removes all USB capability from the DC power analyzer. Both the front panel USB port and the rear panel USB port are removed.
055	Delete data logger This option disables the data logger functionality in the DC power analyzer firmware. The DC power analyzer hardware is unchanged. To enable the data logger functionality at a later time, order the N6705U upgrade kit.
ABA	Full documentation on CD-ROM and printed users guide
RBP	Recessed binding post
900	Power cord, United Kingdom, P/N 8120-1351
901	Power cord, Australia, New Zealand, P/N 8120-1369
902	Power cord, Europe, Korea, P/N 8120-1689

Mainframe	
903	Power cord, USA, Canada, 120 V, P/N 8120-4383
904	Power cord, USA, Canada, 240 V, P/N 8120-0698
906	Power cord, Switzerland, P/N 8120-2104
912	Power cord, Denmark, P/N 8120-2956
917	Power cord, South Africa, India, P/N 8120-4211
918	Power cord, Japan, 100 V, P/N 8120-5342
919	Power cord, Israel, P/N 8120-6800
920	Power cord, Argentina, P/N 8120-6869
921	Power cord, Chile, P/N 8120-6980
922	Power cord, China, P/N 8120-8376
927	Power cord, Thailand, Brazil, P/N 8120-8871
Upgrade	
N6705U-001	Add data logger
	This option activates the data logger functionality in the DC power analyzer firmware. The DC power analyzer hardware is unchanged.
BV9200B	Pathwave BenchVue Advanced Power Control and Analysis Software control up to four instruments
BV9201B	Pathwave BenchVue Advanced Power Control and Analysis Software control one instrument
BV9210B	Pathwave BenchVue Advanced Battery Test and Emulation Software for multiple instruments
BV9211B	Pathwave BenchVue Advanced Battery Test and Emulation Software for a single instrument

For more information, visit www.keysight.com/find/N6705U

Modules

Order 1 to 4 modules to be installed in each N6705C power analyzer mainframe. (To order modules as part of the N6715C, build-to-order systems, see page 30). If the sum of the power of the modules exceeds the available output power rating on the mainframe, see page 18 for an explanation of Keysight's power management capability.

You can individually specify each option for each module. For example, you can order one module with Option 761 Output Disconnect Relays while the remaining modules have no relay options.

As your needs change and you want to change configuration or add more modules to existing N6705 mainframe, use this ordering information to order the required modules.

Modules		
N6730 50 W DC power modules	N6731B	5 V, 10 A, 50 W DC power module
	N6732B	8 V, 6.25 A, 50 W DC power module
	N6733B	20 V, 2.5 A, 50 W DC power module

Modules		
N6730 50 W DC power modules	N6734B	35 V, 1.5 A, 50 W DC power module
	N6735B	60 V, 0.8 A, 50 W DC power module
	N6736B	100 V, 0.5 A, 50 W DC power module
N6740 100 W DC power modules	N6741B	5 V, 20 A, 100 W DC power module
	N6742B	8 V, 12.5 A, 100 W DC power module
	N6743B	20 V, 5 A, 100 W DC power module
	N6744B	35 V, 3 A, 100 W DC power module
	N6745B	60 V, 1.6 A, 100 W DC power module
	N6746B	100V, 1A, 100W DC power module
N6750 high-performance, auto-ranging DC power modules	N6751A	50 V, 5 A, 50 W high-performance autoranging DC power module
	N6752A	50 V, 10 A, 100 W high-performance autoranging DC power module
	N6753A	20 V, 50 A, 300 W high-performance autoranging DC power module (occupies 2 of 4 mainframe slots)
	N6754A	60 V, 20 A, 300 W high-performance autoranging DC power module (occupies 2 of 4 mainframe slots)
	N6755A	20 V, 50 A, 500 W high-performance autoranging DC power module (occupies 2 of 4 mainframe slots)
	N6756A	60 V, 17 A, 500 W high-performance autoranging DC power module (occupies 2 of 4 mainframe slots)
N6760 precision DC power modules	N6761A	50 V, 1.5 A, 50 W precision DC power module
	N6762A	50 V, 3 A, 100 W precision DC power module
	N6763A	20 V, 50 A, 300 W precision DC power module (occupies 2 of 4 mainframe slots)
	N6764A	60 V, 20 A, 300 W precision DC power module (occupies 2 of 4 mainframe slots)
	N6765A	20 V, 50 A, 500 W precision DC power module (occupies 2 of 4 mainframe slots)
	N6766A	60 V, 17 A, 500 W precision DC power module (occupies 2 of 4 mainframe slots)
N6770 300 W DC power modules	N6773A	20 V, 15 A, 300 W DC power module
	N6774A	35 V, 8.5 A, 300 W DC power module
	N6775A	60 V, 5 A, 300 W DC power module
	N6776A	100 V, 3 A, 300 W DC power module
	N6777A	150 V, 2 A, 300 W DC power module
N6780 ~80 W application-specific modules	N6781A	20 V, ± 3 A, 20 W source/measure unit
	N6782A	20 V, ± 3 A, 20 W source/measure unit
	N6784A	± 20 V, ± 3 A, 20 W source/measure unit
	N6783A-BAT	8 V, 3 A, 24 W battery charge/discharge module
N6790 DC electronic load modules	N6783A-MFG	6 V, 3 A, 18 W mobile communications module
	N6785A	20 V, +/-8A, 80 W source/measure unit

Modules		
	N6786A	20 V, +/-8A, 80 W source/measure unit
	N6791A	60 V, 20 A, 100 W DC electronic load
	N6792A	60 V, 40 A, 200 W DC electronic load

	N6731B- N6736B 50 W DC power modules	N6741B- N6746B 100 W DC power modules	N6751A- N6756A high- performance autoranging DC power modules	N6761A- N6766A precision DC power modules	N6773A- N6776A 300 W DC power modules	N6781A, N6782A, N6784A N6785A N6786A SMU modules	N6783A-BAT N6783A-MFG application- specific	N6790 Series Electronic Loads
Output disconnect relays	761	761	761	761	761	Standard	761	Not available
Output disconnect and polarity reversal relays	760	760 ^{1,2}	760 ¹	760 ¹	760 ²	Not available	Not available	Not available
High speed test extensions (HSTE)	054	054	054	Standard	054	Standard	Standard	Standard
200 microampere measurement range	Not available	Not available	Not available	2UA ³	Not available	Not available	Not available	Not available
Commercial calibration with test results data	UK6	UK6	UK6	UK6	UK6	UK6	UK6	UK6
ISO 17025 calibration certificate	1A7	1A7	1A7	1A7	1A7	Not available	1A7	1A7

1. Option 760 is not available on Models N6741B, N6751A, N6752A, N6761A, N6762A.
2. Option 760 limits the output current to 10 A maximum on Models N6742B and N6773A.
3. Option 2UA is only available on Models N6761A and N6762A.

N6715C build-to-order system

To purchase a DC power analyzer, order an N6715C. This model number is a build-to-order system that is shipped as a fully tested and assembled instrument. Each system consists of one mainframe plus optionally 1 to 4 modules. Each mainframe has 4 module slots to hold modules. Each module occupies one module slot, except for the N6753A – N6755A, N6763A – N6766A and N6792A, which occupy two module slots. To specify which modules you want installed in the system, the modules are ordered as options to the system model number. You must order at least one module.

If the sum of the power of the modules exceeds the available output power rating on the mainframe, see page 18 for an explanation of Keysight's power management capability.

If you prefer to purchase a DC power analyzer mainframe and modules as separate pieces, see page 24-25.

Build-to-order system	
N6715C	Build-to-order DC power analyzer system, Consists of 1 N6705C mainframe with total available power of 600 W
Available options to the N6715C system	
1CM113A	Rack mount kit
AKY	Delete front/rear USB This option removes all USB capability from the DC power analyzer. Both the front panel USB port and the rear panel USB port are removed.
ABA	Full documentation on CD-ROM and printed users guide
RBP	Recessed binding post
900	Power cord, United Kingdom, P/N 8120-1351
901	Power cord, Australia, New Zealand, P/N 8120-1369
902	Power cord, Europe, Korea, P/N 8120-1689
903	Power cord, USA, Canada, 120 V, P/N 8120-4383
904	Power cord, USA, Canada, 240 V, P/N 8120-0698
906	Power cord, Switzerland, P/N 8120-2104
912	Power cord, Denmark, P/N 8120-2956
917	Power cord, South Africa, India, P/N 8120-4211
918	Power cord, Japan, 100 V, P/N 8120-5342
919	Power cord, Israel, P/N 8120-6800
920	Power cord, Argentina, P/N 8120-6869
921	Power cord, Chile, P/N 8120-6980
922	Power cord, China, P/N 8120-8376
927	Power cord, Thailand, Brazil, P/N 8120-8871
BV9200B	Pathwave BenchVue Advanced Power Control and Analysis Software control up to four instruments
BV9201B	Pathwave BenchVue Advanced Power Control and Analysis Software control one instrument
BV9210B	Pathwave BenchVue Advanced Battery Test and Emulation Software for multiple instruments
BV9211B	Pathwave BenchVue Advanced Battery Test and Emulation Software for a single instrument

Modules as options to N6715C

Order 1 to 4 modules as options to an N6715C, specify its model number, followed by “–ATO.” For example, to order an N6731B as an option to the N6715C, you would specify “–ATO.” For example, to order an N6731B as an option to the N6715C, you would specify “N6731B–ATO” as the option. (To order modules as separate products, see page 28 - 30). If the sum of the power of the modules exceeds the available output power rating on the mainframe, see page 18 for an explanation of Keysight’s power management capability.

You can individually specify each option for each module. For example, you can order one module with Option 761 Output Disconnect Relays while the remaining modules have no relay options.

Module options for N6715C system		
N6730 50 W DC power modules	N6731B-ATO	5 V, 10 A, 50 W DC power module
	N6732B-ATO	8 V, 6.25 A, 50 W DC power module
	N6733B-ATO	20 V, 2.5 A, 50 W DC power module
	N6734B-ATO	35 V, 1.5 A, 50 W DC power module
	N6735B-ATO	60 V, 0.8 A, 50 W DC power module
	N6736B-ATO	100 V, 0.5 A, 50 W DC power module
N6740 100 W DC power modules	N6741B-ATO	5 V, 20 A, 100 W DC power module
	N6742B-ATO	8 V, 12.5 A, 100 W DC power module
	N6743B-ATO	20 V, 5 A, 100 W DC power module
	N6744B-ATO	35 V, 3 A, 100 W DC power module
	N6745B-ATO	60 V, 1.6 A, 100 W DC power module
	N6746B-ATO	100V, 1A, 100W DC power module
N6750 high- performance, auto-ranging DC power modules	N6751A-ATO	50 V, 5 A, 50 W high-performance autoranging DC power module
	N6752A-ATO	50 V, 10 A, 100 W high-performance autoranging DC power module
	N6753A-ATO	20 V, 50 A, 300 W high-performance autoranging DC power module (occupies 2 of 4 mainframe slots)
	N6754A-ATO	60 V, 20 A, 300 W high-performance autoranging DC power module (occupies 2 of 4 mainframe slots)
	N6755A-ATO	20 V, 50 A, 500 W high-performance autoranging DC power module (occupies 2 of 4 mainframe slots)
	N6756A-ATO	60 V, 17 A, 500 W high-performance autoranging DC power module (occupies 2 of 4 mainframe slots)
N6760 precision DC power modules	N6761A-ATO	50 V, 1.5 A, 50 W precision DC power module
	N6762A-ATO	50 V, 3 A, 100 W precision DC power module
	N6763A-ATO	20 V, 50 A, 300 W precision DC power module (occupies 2 of 4 mainframe slots)
	N6764A-ATO	60 V, 20 A, 300 W precision DC power module (occupies 2 of 4 mainframe slots)
	N6765A-ATO	20 V, 50 A, 500 W precision DC power module (occupies 2 of 4 mainframe slots)

Module options for N6715C system		
	N6766A-ATO	60 V, 17 A, 500 W precision DC power module (occupies 2 of 4 mainframe slots)
N6770 300 W DC power modules	N6773A-ATO	20 V, 15 A, 300 W DC power module
	N6774A-ATO	35 V, 8.5 A, 300 W DC power module
	N6775A-ATO	60 V, 5 A, 300 W DC power module
	N6776A-ATO	100 V, 3 A, 300 W DC power module
	N6777A-ATO	150 V, 2 A, 300 W DC power module
N6780 up to 80 W application-specific modules	N6781A-ATO	20 V, ± 3 A, 20 W source/measure unit
	N6782A-ATO	20 V, ± 3 A, 20 W source/measure unit
	N6784A-ATO	± 20 V, ± 3 A, 20 W source/measure unit
	N6785A-ATO	20 V, ± 8 A, 80 W source/measure unit
	N6786A-ATO	20 V, ± 8 A, 80 W source/measure unit
	N6783A-BAT	8 V, 3 A, 24 W battery charge/discharge module
	N6783A-MFG	6 V, 3 A, 18 W mobile communications module
N6790 DC electronic load module	N6791A-ATO	60 V, 20 A, 100 W DC electronic load
	N6792A-ATO	60 V, 40 A, 200 W DC electronic load

Need a power solution for ATE?

The Keysight N6700 modular power analyzer is small, flexible, and fast

- Ideal for ATE systems in R&D, design validation, and manufacturing
- Small size: Up to 4 outputs in 1U of rack space
- Flexible, modular system: You can mix and match power levels and performance levels to optimize your investment
- Uses the same modules as the N6705 DC Power Analyzer
- Fast command processing time to improve throughput
- Connect via GPIB, LAN, or USB
- Fully compliant to LXI Class C specification
- Electronic loads up to 200 W

Complete specifications can be found in the *N6700 Modular Power System Data Sheet*, publication 5992-1857EN. For more information, go to www.keysight.com/find/N6700



Learn more at: www.keysight.com

For more information on Keysight Technologies' products, applications or services, please contact your local Keysight office. The complete list is available at: www.keysight.com/find/contactus

